

66  
COMPACT DISC  
PLAYER

---

---

INSTRUCTION BOOK

QUAD

## **BRIEF OPERATING INSTRUCTIONS**

Remove the transit screws.

Plug the AC supply lead and the signal lead supplied into the quad control unit and the CD player.

- Switch on.
- Press the drawer button. The drawer compartment will open.
- Place disc, label side up, in drawer compartment.
- Gently push front of drawer. It will close by itself.
- The disc will now start to play from the beginning.
- For full remote control operation and track programming refer to appropriate section of the instruction book.

# CONTENTS

	page
Introduction .....	2
Guarantee .....	2
Service .....	2
Accessories Supplied .....	3
Installation .....	3
Positioning The CD Player .....	4
Connection To The Amplifier .....	4
Switching On And Off .....	4
Simple Operation Direct To Play .....	4
(without remote control)	
Full Operation With Quad Remote Control .....	5
Programming Tracks .....	7
Using The Index Keys .....	8
Player Maintenance .....	9
Disc Maintenance .....	9
Specification .....	10
Controls And Display Indications .....	12
Connecting Sockets .....	12
Front And Rear View .....	15
Remote Control Layout .....	16

**CLASS ONE  
LASER PRODUCT**

## INTRODUCTION

The Quad CD player is designed for the serious music listener. It is simple to operate and has the minimum of controls. While it is anticipated that the majority of discs will be listened to from the beginning, simple programming permits tracks to be selected and played in any sequence.

The player disc drawer will accept compact audio discs in the 'normal' and 'CD single' format without any special adapters.

The main operating controls are separated from the player and all major functions are available via a remote control unit, a compact hand held type being supplied as standard.

When the Quad CD player is used with the Quad 34 or Quad 44 control units the optional remote control stick with 34/44 style push buttons is appropriate. It can be placed wherever is most convenient, on top or in front or to one side of the player or by the listening position.

More than one remote control can be used and it is not necessary to point the unit at the CD player.

Performance of the Quad CD player is as accurate as it is possible to achieve by careful design, selection of components and rigorous test procedures.

## GUARANTEE

The Quad CD player is guaranteed against any defect in material and workmanship for a period of twelve months from the date of purchase. Within this period we undertake to supply replacement parts free of charge provided that the failure was not caused by misuse, accident or negligence. Freight and labour costs are not covered unless by local agreement. Within the UK this guarantee does not limit your statutory rights. A separate guarantee card is not supplied and your guarantee begins on the day of purchase.

## SERVICE

If servicing is required the CD player should be returned to the supplier, the distributor for the country of purchase or Quad Electroacoustics Ltd. A brief note should be enclosed giving your name and address and the reason for returning it.

Quad offers same-day service from Monday to Friday except for bank holidays. Please contact us to make an appointment.

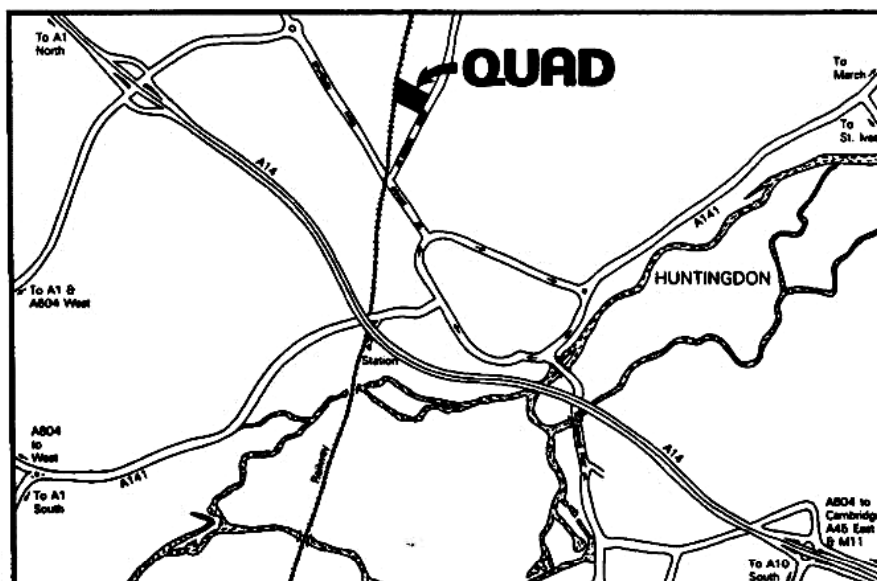

## ACCESSORIES SUPPLIED

AC supply lead 0.6m long  
Signal lead 0.5m long  
Remote control

Type No. QSPRS06  
Type No. QP2P2SA  
Type No. QCDREMA

**Important** - The original packing and the two transit screws, should be retained in case the player has to be returned for service.

## INSTALLATION

**Transit Screws** - Before using the CD player first remove the two transit screws located on the bottom panel. The screws should be stored in the slots provided in the packing as they **MUST** be refitted if the player is returned for service, or transported over any distance.

**Checking the AC Power Supply** - The rating plate on the back of your player shows the AC supply voltage for which the player is set. If your AC supply is different from that indicated, ask your dealer or our Service Department to change the voltage setting for you.

**Connecting to the AC Power Supply** - The player is supplied with a 0.6m long AC supply lead already fitted with a standard 3-pin Euro plug for connection to the AC outlet socket fitted on the back of current Quad equipment.

For connection to other equipment, or direct to the mains supply, your dealer can supply a longer lead to which a suitable plug should be fitted, as explained below:-

### **IMPORTANT** - Fitting a mains plug.

The wires in the mains lead are coloured:

Blue - Neutral

Brown - Live

The Brown wire must be connected to the terminal marked L or coloured Red. The Blue wire must be connected to the terminal marked N or coloured Black.

**Note** - The player must be protected by a 3A fuse when a 13A plug is used, or if another type of plug is used, by a 5A fuse either in the plug or adapter, or at the distribution board. If in doubt consult a qualified electrician.

## **POSITIONING THE CD PLAYER**

The CD Player can be positioned free-standing or stacked with other components. Never place the player in persistent direct sunlight or near any heat source.

**Free Standing** - If free standing the player must always be placed horizontally on a flat firm surface, not on a soft mat or anything similar.

**Stacked** - If the player is stacked on top of other equipment, it should not stand directly on top of a high power amplifier as such amplifiers generate a substantial amount of heat.

**Warning** - Do not place audio or video cassettes on top of the player because of the effects of the magnetic fields produced by the player's mains transformer.

## **CONNECTION TO THE AMPLIFIER**

At the back of the player you will find the sockets for the connecting lead to the amplifier. Insert the White plug of the audio connecting lead supplied to the L socket (white = left channel) and the Red plug to the R socket (red = right channel).

Insert both the plugs, at the other end of the lead, into the corresponding CD or AUX sockets of your amplifier system.

If necessary, you can use the TUNER or TAPE IN sockets, but never the DISC/PHONO/PICK-UP sockets which are totally unsuitable for CD players. The sockets marked DIG OUT and CONTROL IN OUT can be ignored for the time being.

## **SWITCHING ON AND OFF**

Press the **ON-OFF** button. This has a sequential action so pressing it again will switch the player off.

As soon as the player is switched on, with the disc drawer empty, the display flashes briefly and then '- - -' appears continuously.

## **SIMPLE OPERATION DIRECT TO PLAY (without remote control)**

**Loading a Disc** - Open the disc drawer by pressing the **DRAWER** button. Carefully place the disc, label side up, in the centre of the drawer compartment.

Close the drawer by pushing it gently. It will then close by itself and after a short pause, while the laser pick-up searches for the first track, start to play the whole disc starting from the beginning.

Whilst the disc is playing the display will show the track number and the elapsed playing time plus any index details present on the disc.

**Unloading a Disc** - Press the **DRAWER** button. The disc will stop playing and the drawer will open. Remove the disc carefully and return it to its holder. To close the drawer push it gently or press the **DRAWER** button again. It will close by itself.

To keep out dust which could fall on the laser pick-up do not leave the drawer open unnecessarily.

**Note** - If **'ERROR'** appears for approx 3 seconds after the drawer closes, followed by '- - -', it means you have either loaded the disc upside down or it is otherwise unacceptable ( dirty, badly scratched or defective in some way), or that you have not loaded a disc at all.

## **FULL OPERATION WITH QUAD REMOTE CONTROL**

**Loading a Disc** - Open the disc drawer by pressing the **DRAWER** button. Carefully place the disc, label side up, in the centre of the drawer compartment.

Close the drawer by pressing the **DRAWER** button. After a short pause, while the laser pick-up scans the disc, the display will show the number of tracks on the disc and the total playing time.

**Playing a Complete Disc** - If you simply want to play the complete disc, you need not wait until the number of tracks and the total playing time are displayed.

Immediately the drawer closes you can press **PLAY**. Once the laser pick-up reaches the beginning of the first track '1' will appear in the display and at the same time the elapsed track playing time shown, in minutes and seconds.

As each track ends the track number changes to the next track being played, and the elapsed playing time changes to that of the track being played.

As soon as all the tracks have been played the disc will stop and the display will show the total number of tracks and the total playing time.

**Pausing During Play** - For short interruptions press **PAUSE**; **'PAUSE'** will appear in the display. To restart press **PAUSE** again and play will start from the exact point where it was interrupted.

**Going Back to the Beginning of a Track** - To go back to the beginning of the track being played, briefly press **PLAY**. The track then starts again from the beginning.

**Moving to Another Track** - At any time during play you can choose another track. This can be a later or an earlier track. Just select the required track number, using the numeric keypad, and after a short pause the track will be played.

Alternately you can skip tracks by pressing the appropriate **TRACK** key until the desired track number is shown in the display, as explained below.

**Selecting a Later Track** - Press **TRACK >** until the desired track number is displayed. Should you press **TRACK >** whilst the last track is playing **'ERROR'** will appear, to remind you that there is no next track, and the last track will continue to play.

You can also use **TRACK >** to preview a disc by listening to the beginning of each track.

**Selecting a Previous Track** - Press **TRACK <** until the desired track number is displayed.

Should you press **TRACK <** whilst the first track is playing '**ERROR**' will appear, to remind you there is no previous track, and the first track will be replayed from the beginning.

**Note** - Each time you press a **TRACK** key the player will skip one track at a time. If you keep the key depressed it will keep skipping tracks until the key is released.

**Beginning at a Specific Track** - Instead of the first track you can start play from any other track. In this case you wait until the content of the disc has been read. The highest selectable track number is then shown with the total disc playing time.

Bring the number of the required track into the display using either the numeric keypad or the **TRACK < >** keys.

Then start play by pressing **PLAY**.

**Finding a Particular Passage on a Disc** - During play you can quickly find a particular passage in a track by pressing, and holding down, one of the **FAST SEARCH << >>** keys.

While you hold down **FAST SEARCH <<** the laser pick-up runs back towards the beginning, and while you hold down **FAST SEARCH >>** the laser pick-up runs towards the end of the disc.

By alternating between these keys you can locate any particular part or passage.

As soon as you release a key, play starts at once.

If you continue to hold down the key during fast search, the disc will play at three successively faster speeds; for the first few seconds slightly faster than normal, then at a higher speed, and finally (after about 8 seconds) at maximum speed.

At the first two speeds the sound can still be heard, though speeded up but at the fastest speed it disappears. When searching for a passage by ear, it is therefore advisable to release the key at that moment so you can retain the sound as an aid to searching.

You can, of course, search with the aid of the playing time display and in this case there is no need to avoid using the fastest speed.

Should you, by pressing **FAST SEARCH <<**, take the laser pick-up beyond the run-in for the first track '**ERROR**' will appear and the laser pick-up stops at the first track. The disc will continue to spin so that playback resumes as soon as you release the key.

Should you, by pressing **FAST SEARCH >>**, take the laser pick-up beyond the run-out of the last track '**ERROR**' will appear and the laser pick-up will jump back about 5 seconds of playing time and remain there until you release the key.



**To Stop Play** - To stop play before the end of a disc press **STOP**. The display will then show the total number of tracks on the disc and the total playing time.

If you want to stop play and also remove the disc, without using the remote control panel then just press the **DRAWER** button.

The disc will immediately stop playing and the drawer will open. Do not forget to close the drawer after you remove the disc.

## **PROGRAMMING TRACKS**

Instead of playing a complete disc, you can choose a number of tracks and play only these. You can also decide on the playing sequence.

To do this it is necessary to store your choice as a programme in the player's memory. You can only store each track once and if you make a mistake '**ERROR**' will appear in the display.

Programming is only possible when a disc is in the player and its content has been read by the laser pick-up to determine the highest track number that can be chosen.

To store the track numbers that you want to play (these can be found from the contents list supplied with the disc), bring up each required track number in turn to the display, using either the numeric keypad or the **TRACK < >** keys and then put it in the player's memory by pressing **PROGR**.

Do not allow more than 8 seconds to elapse between selecting a track number and storing it otherwise the microprocessor in the player will assume that you have changed your mind (the dash after the track number stops flashing) and that track can now not be stored. However, should this happen, you can re-activate the missed track number by bringing up the previous or following track number and then returning immediately to the track required.

During programmed play all the player controls remain operative except at the very beginning of each selected track.

**Example** - From a disc containing 12 tracks you want to play tracks 9, 5, 1 and 11 in that order.

Load the disc and close the drawer with the **DRAWER** button. When the disc content has been read the display will show '**12**', and the total playing time.

Now bring '**9**' into the display, using either the numeric keypad or the **TRACK < >** keys, and then press **PROGR**. The flashing dash after the selected track number is now replaced by a '**P**' (for Programme) to show that the track has been stored. The display will show '**9 P**'.

Now go to track '**5**' and press **PROGR** again. The display will now show '**5 P**'.

Continue choosing the other tracks in the same way using and storing them with **PROGR**. As soon as you have stored the last track number the display will show '**11 P**'. This will remain until you start play, by pressing **PLAY**.

If you make a mistake and store an incorrect track number, this can be rectified by going to the previous or following track number, returning to the wrong track number and then pressing **PROGR** again. To show that the wrong track number has been erased, the '**P**' after it is replaced by a '**C**' (for Cancel).

Using our example; you have stored '**4**' instead of '**5**'. Go back to '**3**', return to '**4**' and then press **PROGR**. The display shows '**4 C**'. Now proceed by storing '**5**'.

**Checking the Memory Contents** - During programming or when you have finished programming, you can check the contents of the memory by pressing **PROGR**. All the selected track numbers will be displayed in the programmed sequence.

In our example; '9 - 5 - 1 - 11 P'.

If after pressing **PROGR** 'ERROR' appears, this means that no tracks have been stored.

**To Erase the Whole Programme Memory** - You can clear a programme at any time by opening the disc drawer. Pressing **STOP** will also clear the programme but if the disc is playing **STOP** has to be pressed twice, once to stop play and once to clear the programme.

**To Start Play** - Press **PLAY**. The track number of the first programmed selection will be displayed and this will change, as each selected track is played, so that the progress of play can be followed. You can check the tracks still to be played, at any time, by pressing **PROGR**. First the number of the track playing will be displayed, followed consecutively by the remaining track numbers.

You can return to the beginning of a programmed track, or to the previously programmed track by pressing **TRACK <**. If you want to go on to a following programmed track press **TRACK >**. You can also search for a particular passage using the **FAST SEARCH << >>** keys but this is limited to the track currently being played to prevent disturbing the programme sequence. When the track limits are reached 'ERROR' appears and the laser pick-up stops until the key is released.

To hold play at any time during a programme press **PAUSE**. Pressing **PAUSE** again will restart play.

When all the tracks have been played the disc stops. However, the current programme is still retained in the memory so pressing **PLAY** again will repeat the sequence. To erase the programme open the drawer compartment or press **STOP**.

## USING THE INDEX KEYS

These are used for selecting a specific part of a track on discs recorded with index numbers and up to 99 can be selected per track. This facility is only usable on special discs with index information and this will be detailed in the disc content instructions supplied with the disc.

The required index number can be entered in both play and standby modes. Should you select an index for a disc not incorporating this facility 'ERROR' will appear briefly, whilst the disc is playing, followed by normal operation with the display of track number and elapsed playing time.

**Selecting a Track Index** - First decide which track and index numbers you want from the information supplied with the disc. Select the track and then use the **INDEX < >** keys to show the required number in the display; press **INDEX >** to step to higher numbers and **INDEX <** to step down to lower numbers. If either key is held down stepping will continue until the key is released. Note only one index can be selected at a time.

During play, after a short pause, the chosen track index will be automatically selected. From the stop mode the chosen track index will be selected as soon as **PLAY** is pressed.

## **PLAYER MAINTENANCE**

The player mechanism is provided with self-lubricating bearings and no routine maintenance is required.

If necessary the case can be cleaned with a soft brush or, for more stubborn marks, a slightly moistened lint-free cloth. In this event remove the mains plug from the supply socket. Do not use cleaning agents, solvents or abrasives.

The disc compartment should be kept free from dust.

**Remote Control Battery Replacement** - In normal use the batteries fitted should last for approximately one year. Low batteries will cause erratic operation and reduce the operating range.

To replace the batteries turn the unit upside down and slide off the battery compartment lid as shown. Insert the new batteries carefully and refit the battery compartment lid. The control is now ready for operation.

Always use leakproof batteries (three AAA size alkaline cells) and never mix battery types or re-use old batteries.

## **DISC MAINTENANCE**

Although the music tracks on a compact disc are covered with a protective layer, it is still advisable to handle a disc carefully. As long as you always pick up discs by the edge and put them back in their protective holders immediately after use, cleaning will not normally be necessary.

However, should fingerprints, dust or dirty marks appear on a disc you can wipe them off with a soft lint free cloth. Always wipe the disc in a straight line from the centre to outer edge.

If necessary you can breathe on the disc first but detergents, abrasive cleaning agents or cleaning materials for conventional records must never be used!

*Never write on the disc label; this can cause irreparable damage to the music tracks.*

## SPECIFICATION

### Main Unit

Operation:	Full function by infrared remote control or simple direct to play operation without remote control
Number of channels:	2
Frequency response:	20 - 20,000 Hz
Amplitude linearity:	+/- 0.1 dB 20 - 20,000 Hz
Phase linearity:	+/- 0.5° 20 - 20,000 Hz
Dynamic range:	>96 dB 20 - 20,000 Hz
Signal/noise ratio:	>96 dB 20 - 20,000 Hz
Channel separation:	>96 dB 20 - 20,000 Hz
Total harmonic distortion:	0.003% 20 - 20,000 Hz
Wow and flutter:	Below measurement levels
D/A conversion:	Quadruple oversampling (176.4 kHz) with digital filter and two 16-bit D/A converters
Error correction system:	Cross Interleaved Reed Solomon Code (CIRC)
Audio output:	2 V rms max. 300 mV on normal programme material. Minimum load impedance 10 k $\Omega$
Optical readout system:	Laser semi-conductor AlGaAs wavelength 800 nm
Sampling frequency:	44.1 kHz
Digital output:	For digital signal processors
Remote control Interface:	RC-5 system
Mains voltage:	110V,127V,220V,240V (changed by links on PCB) 50 - 60 Hz: see rating plate on player back. Double insulated
Fuse (anti-surge):	220-240V 160 mA: 110-127V 315 mA
Power consumption:	25W approx.
Dimensions:	Width 321 mm; height 80 mm; depth 275 mm approx. drawer opens by 145 mm approx.
Weight:	3.5 kg approx.

## **Remote Control**

<b>System:</b>	Infrared
<b>Dimensions:</b>	Width 48 mm; length 174 mm; thickness 22 mm approx.
<b>Weight:</b>	100g (inc batteries) approx.
<b>Battery life:</b>	One year approximately with normal operation, using alkaline cells
<b>Battery type:</b>	Three AAA size alkaline cells

## **Disc Specification**

<b>Diameter:</b>	120 mm and 80 mm
<b>Thickness:</b>	1.2 mm
<b>Direction of rotation:</b>	Anti-clockwise (seen from reading side)
<b>Scanning velocity:</b>	1.2 - 1.4 m/s
<b>Rotation speed:</b>	500 - 200 rpm
<b>Stereo playing time:</b>	74 minutes max. (theoretically)
<b>Track pitch:</b>	1.6 $\mu$ m
<b>Material:</b>	Plastic

*The right is reserved to alter performance and specifications as required.*

*This compact disc player complies with the radio interference requirements as laid down in EEC (European Economic Community) regulations.*

## **CONTROLS AND DISPLAY INDICATIONS**

Your Quad compact disc player is very easy to operate but to assist you the operating controls and display indications are described below. The following terms for the keys etc. are used throughout the text.

### **Player Controls**

- ON OFF Button:** For switching the player mains on and off.
- DRAWER Button:** To open and close the disc loading drawer.

### **Remote Control keys**

- PLAY/REPLAY:** For starting play.
- PAUSE:** To interrupt play for short periods. Press to pause, press again to start.
- STOP:** For stopping play and for erasing programmes.
- PROGR:** For storing track numbers in the memory when programming and for displaying programmes stored. Up to 99 tracks can be stored.
- TRACK < >:** For skipping tracks during play and selecting tracks when programming.
- 0 - 9:** For choosing a track during play and when programming.
- FAST SEARCH << >>:** For fast search of a particular passage during play.
- INDEX < >:** For selecting a particular index in a track on a discs with index markings.

## **CONNECTING SOCKETS**

- OUTPUT L R:** Audio output for connection to the CD input of an amplifier.
- DIG OUT:** Digital output for future CD applications such as CD - ROM or digital signal processing.
- CONTROL IN OUT:** For connection of alternative remote controls using the RC-5 system.
- POWER:** For the AC power supply input lead.

## DISPLAY INDICATIONS

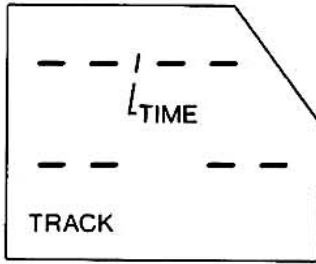

**ON** - As soon as the player is switched on, with the disc drawer empty, the display flashes briefly and then '----' appears continuously.

**STANDBY** - As soon as the disc drawer is closed '----' flashes as a sign that the laser pick-up is scanning the disc. This keeps flashing until scanning is completed.

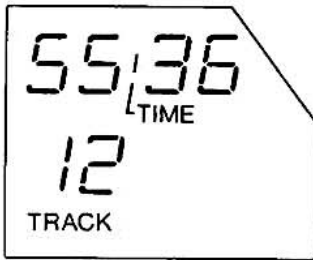

**PLAYING TIME** - When the contents of a disc have been read the highest track number is indicated together with the total playing time in minutes and seconds.

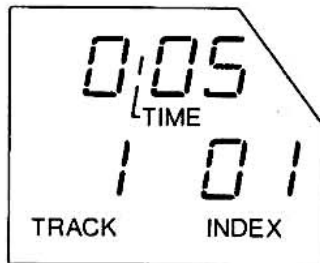

**PLAY** - As soon as play starts the track number and the elapsed playing time is indicated.

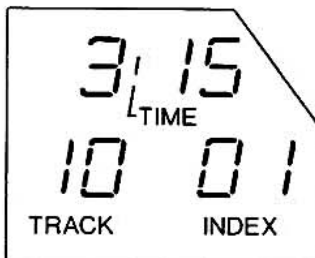

**TRACK NUMBER** - As play progresses the number of the track being played is indicated.

**ELAPSED PLAYING TIME** - During play the elapsed playing time of the track being played is indicated in minutes and seconds.

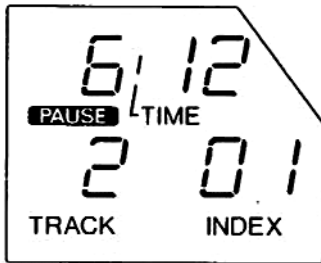

**PAUSE** - When play is interrupted 'PAUSE' appears. This disappears as soon as play is resumed.

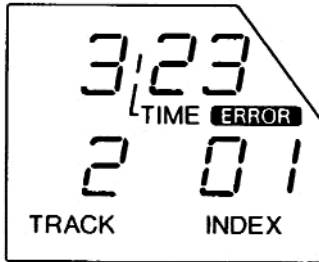

**ERROR** - 'ERROR' appears briefly when you make an operating or programming mistake.

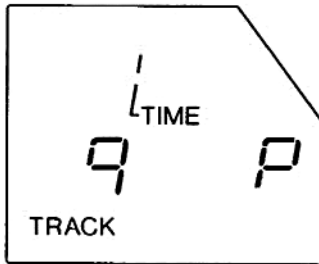

**PROGRAMMING** - When tracks are stored during programming a 'P' is displayed after the track number.

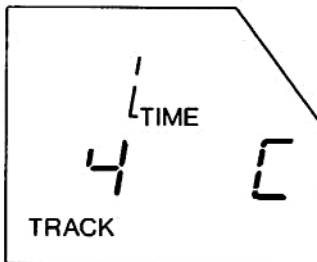

**PROGRAMMING** - If a track is cancelled the 'P' is replaced by a 'C'.

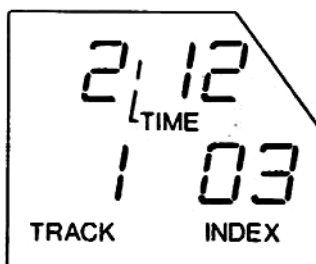

**INDEX** - When an index number is selected this is displayed. Also displays the index numbers as a track is being played. For discs without indexing this will always indicate '01'.



**FRONT VIEW**

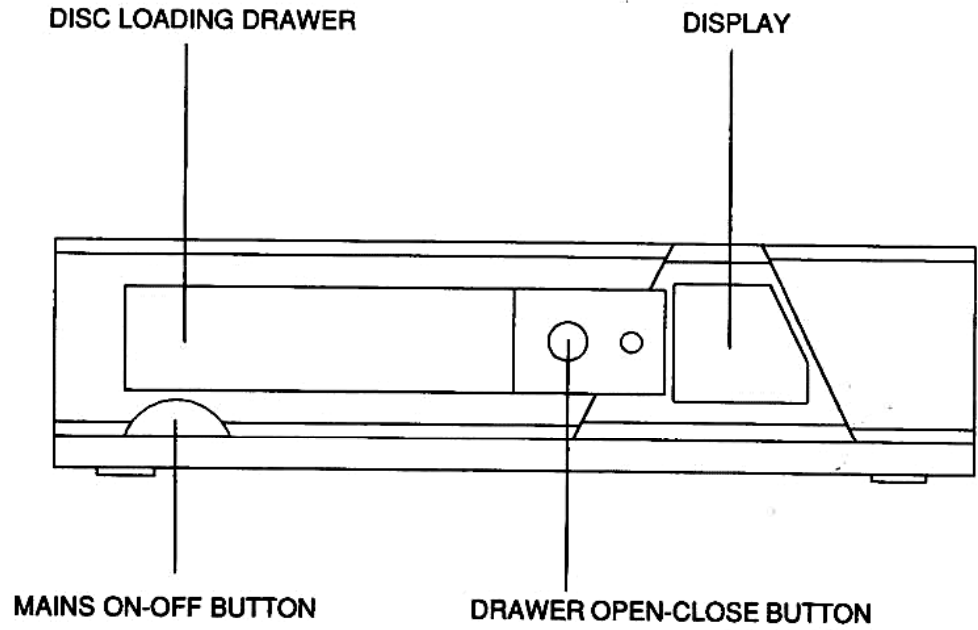

**REAR VIEW**

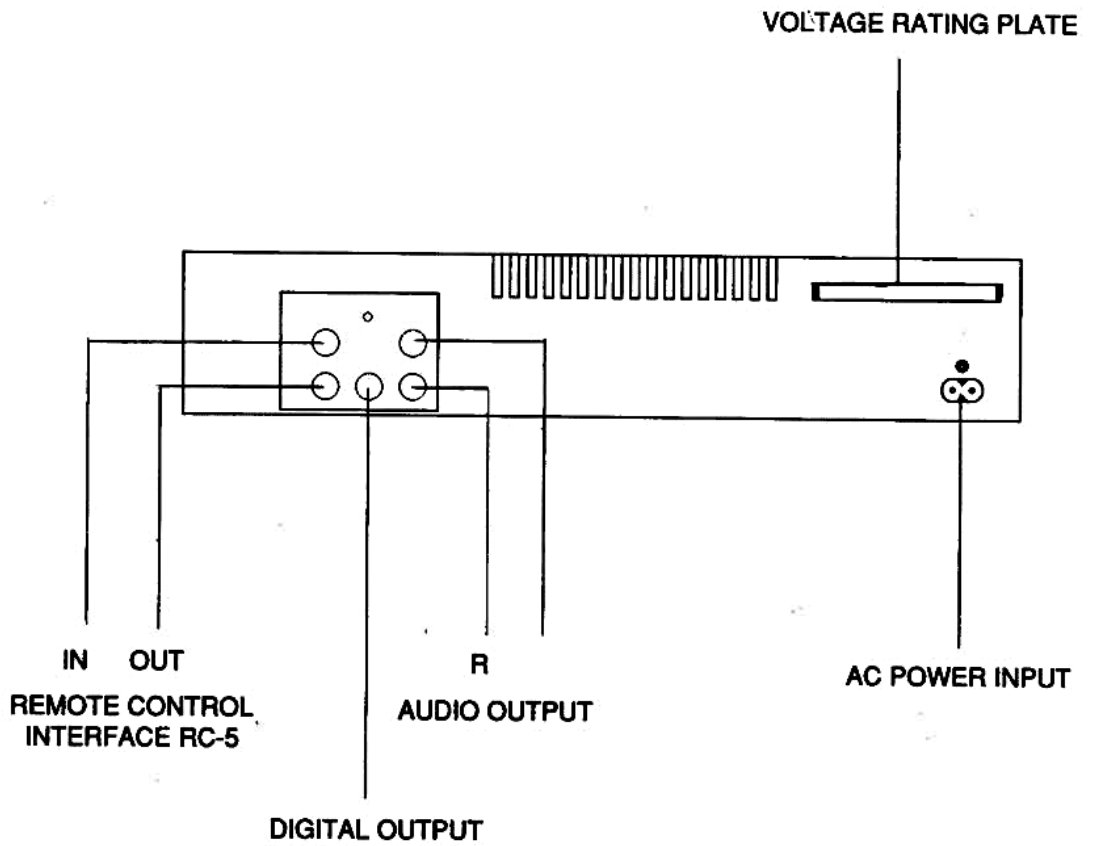

# REMOTE CONTROL LAYOUT

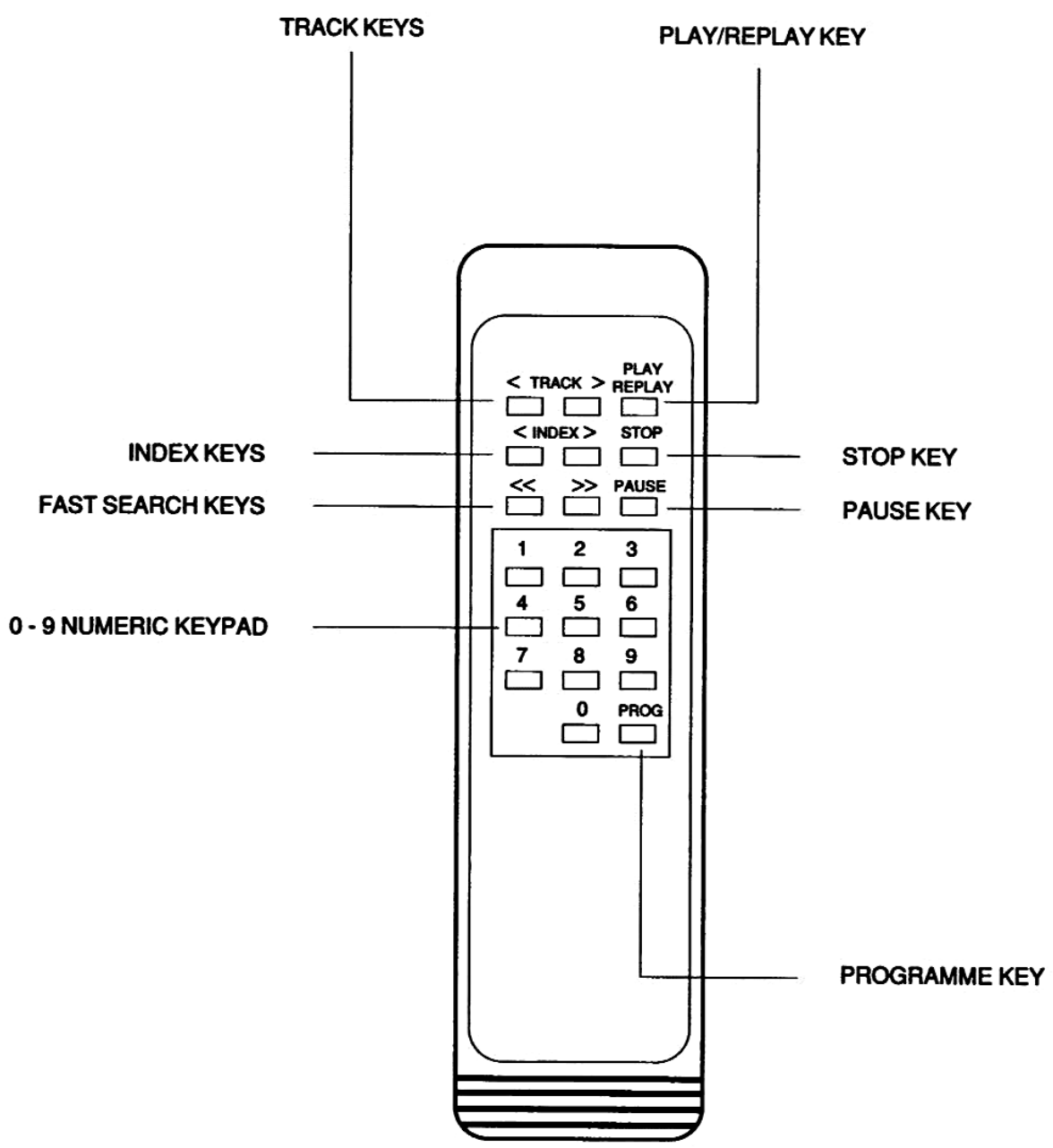



Quad Electroacoustics Ltd Huntingdon PE18 7DB United Kingdom  
Telephone:0480 52561 Telex:32348 QUAD G Fax:0480 413403

QUAD is a registered Trade Mark